

Site manual

Resin technical
coverings

- Wallcrete
- Wallpaper
- Patina

kerakoll

Contents

Resin technical coverings

Wallcrete	06
Wallpaper	22
Patina	38



Resin technical coverings

Wallcrete
Wallpaper
Patina

Use

Technical walls (bathrooms, shower interiors and kitchens) in domestic and commercial environments.

Wallcrete

Water-based resin covering with a coloured trowelled texture.

The matt and monochromatic surface of Wallcrete is characterized by irregularities and textured details resulting from an exclusive hand-made processing that enhances the natural vibration of colours.



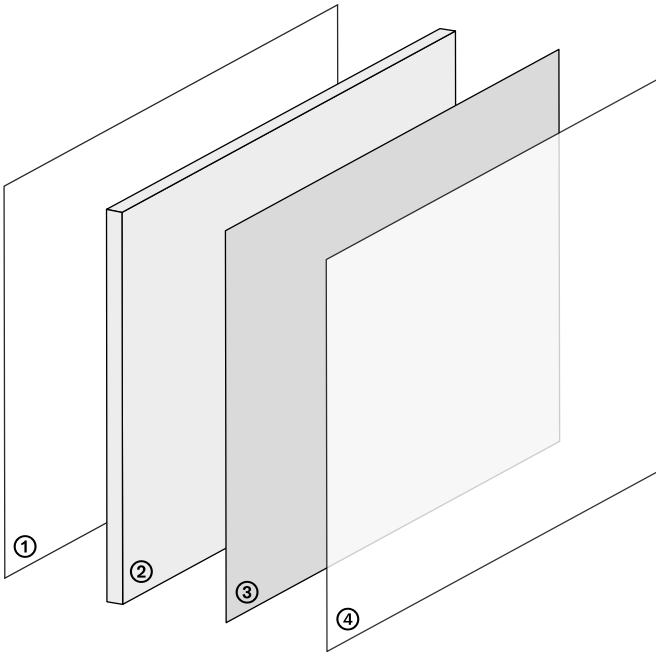

① Layer → Priming according to the substrate

Universal Wall Primer

Keragrip Eco Pulep

② Layer → Skimming

Wallcrete

③ Layer → Coloured finish

Decor

④ Layer → Transparent protective

Microresina Xtreme Invisible

① Layer → Priming

Preparation

Warnings about substrates

- The substrates must be permanently dry and free from rising damp.
- Maximum residual moisture on cement based and ceramic substrates: < 2%.
- Maximum residual moisture on gypsum and anhydrite based substrates: < 1%.
- Temperature range for application: from +10 °C to +30 °C.
- Relative environmental humidity: ≤ 75%.

Suitable substrates

- Cement based plasters and finishing products, lime and gypsum.
- Substrates made with plasterboard and fibre-cement panels.
- Ceramic, glass mosaic and natural stone previous coatings.
- Plywood and MDF panels.
- Waterproofing carried out with systems such as Aquastop Extreme, Aquastop Nanogum, Nanoflex No Limits, Nanodefence Eco or Aquastop Nanoflex (proceed straightaway with Wallcrete).

Universal Wall Primer

Water based universal primer for walls.



Products

Pack - 1 l - 5 l - 10 l



Coverage

≈ 150 - 200 ml/m²



Tools

Brush and roller

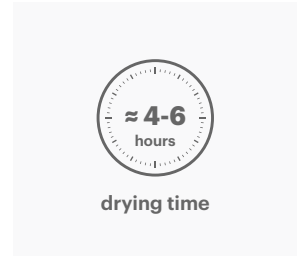

Time

Waiting time for overlaying:
≈ 4 - 6 hours

Keragrip Eco Pulep

Organic preparation coat for treatment and cleaning of non-absorbent substrates.



Products

Pack - 1 l - 10 l



Coverage

≈ 30 ml/m²

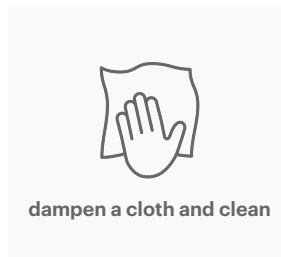

Tools

cloth

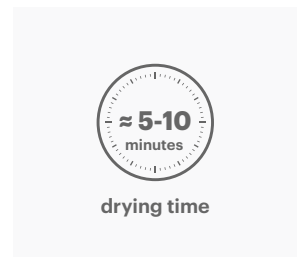

Time

Waiting time for overlaying:
≈ 5-10 minutes

② Layer → Skimming

Preparation

Ready-to-use

→ Remix the product inside the container to ensure the mixture is of an even consistency.

Wallcrete

Texturizing base finishing coat for **Wallcrete** resin covering.



Products

Pack – 5 kg - 15 kg



Coverage

≈ 3.0 kg/m² for three coats

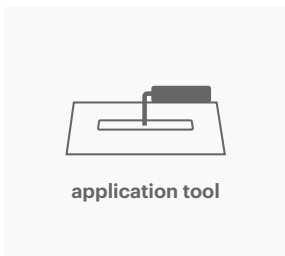

Tools

Trowel

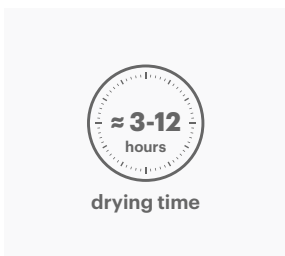

Time

Once the material has hardened: ≈ 3-12 hours

② Layer → Skimming

Wallcrete



→ Apply the 1st coat of **Wallcrete** spreading it out completely in order to grout the joints, any unevenness of the ceramic tiles or defects of the wall.

→ The 2nd coat has the purpose to completely cover the substrate defects and even the wall.

Tip: on walls presenting traces, cracks or unstable crazing, insert Net 90 reinforcing mesh in the 1st coat of **Wallcrete**.

If any wall need to be corrected or levelled, order Wallzero.

→ To speed up drying times (especially in damp environments and/or with little air circulation), the use of a fan is recommended.



- Apply the 3rd coat once the material has hardened (3-12 hours).
- The 3rd coat has the purpose to define the final texture of the **Wallcrete** surface; therefore, it is necessary to spread the product smoothing it out completely with small and even strokes of the spreader.

Tip: in order to improve the visibility of the processing, **Wallcrete** in paste form can be coloured by adding a few drops of Decor of the same shade as the final colour.

③ Layer → Coloured finish

Preparation

Ready-to-use

→ Remix the product inside the container to ensure the mixture is of an even consistency.

Decor

Water-based decorative resin-paint with washable and wipeable matt-finish and high chromatic intensity.



Products

Pack – 1,5 l - 4 l - 10 l



Coverage

≈ 200 ml/m² for two coats

Dilution – max 5-10%

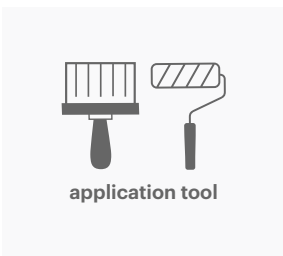

Tools

Brush and roller

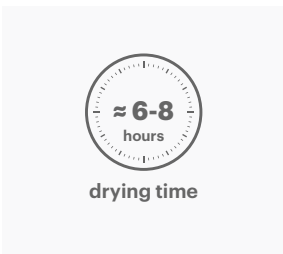

Time

Waiting time between 1st and 2nd coat: ≥ 6 hours

③ Layer → Coloured finish

Decor



- After 4-6 hours from the **Wallcrete** application, sand the surface with 80-120-grain sandpaper in order to remove any small imperfections and to make the surface smooth and pleasing to the touch.
 - **Decor** must be carefully applied with a roller over the whole surface in 2 coats, either pure or diluted to a maximum of 5 - 10%.
- Tip:** proceed with shaping by passing over the laid film while it is still wet.

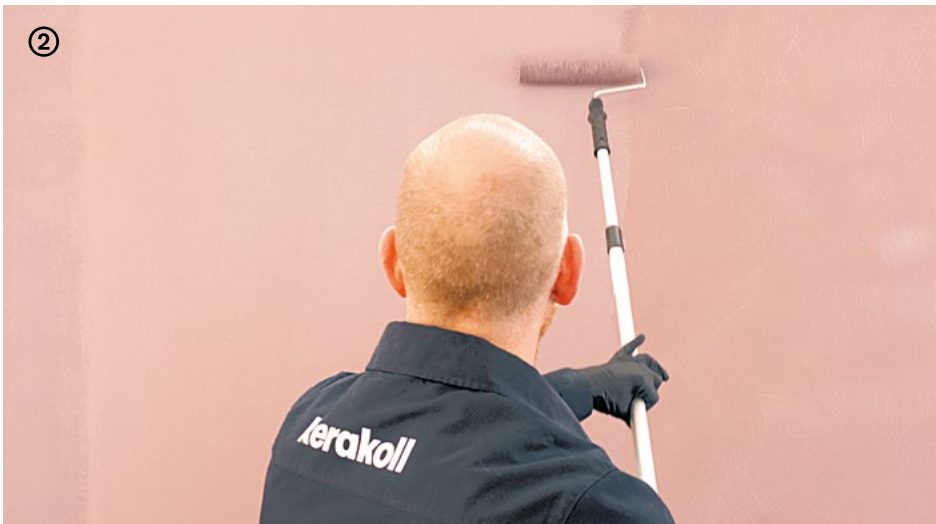

→ Leave at least 6 hours between the 1st and 2nd coats.

Tip: in cases where different batches of coloured product are used, it is advisable to mix the various quantities together so as to avoid slight differences in tone.

④ Layer → Transparent protective

Preparation

Warning

- Shake part A before use and pour into a clean container.
- Add the hardening compound whilst stirring in the ratio part A : part B = 10 : 1.
- Mix well, then dilute 10% using clean water and mix again.
- At the end of the cycle, wait for 5 days before direct, continuous contact with water.

Microresina Xtreme Invisible

Transparent water based micro-resin for the protection of **Wallcrete** technical covering.



Products

Pack - (1+0.1) 1,1 l e (2,5+0,25) 2,75 l



Coverage

≈ 120 ml/m² for two coats

Dilution - max 10 - 15%

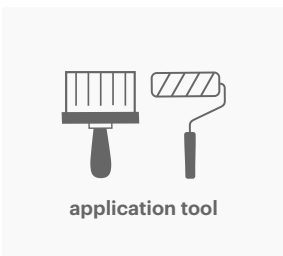

Tools

Brush and roller

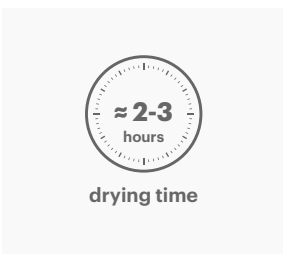

Time

Waiting time between 1st and 2nd coat: ≥ 2 - 3 hours

If > 12 hours elapse, sand with Softpad

④ Layer → Transparent protective

Microresina Xtreme Invisible



→ Before use, stir part A, add the hardening compound whilst stirring in the ratio part A : part B = 10 : 1.

→ Mix well, then dilute 10% using clean water and mix again.

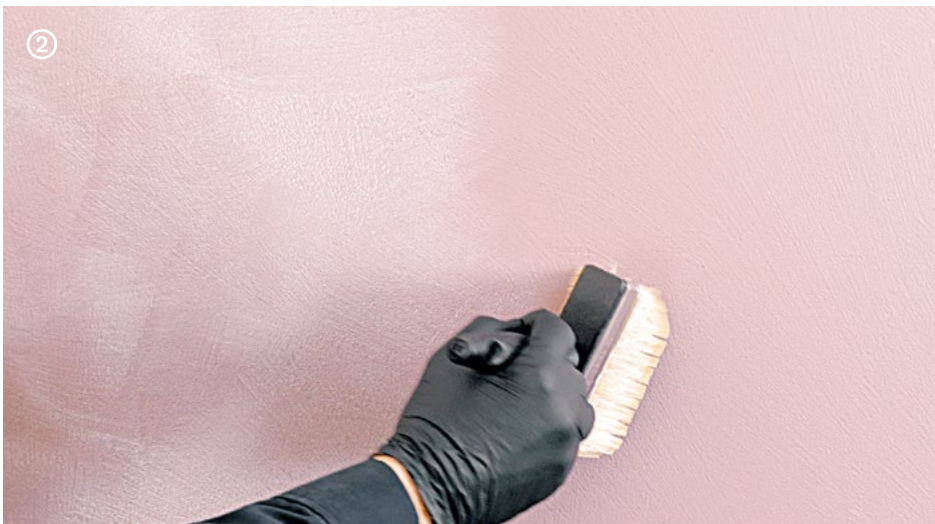

→ Apply 2 coats of **Microresina Xtreme Invisible** with **Roller Plus** or a flat brush respecting the coverage of $\approx 60 \text{ ml/m}^2$ per coat.

→ Leave between 2 hours (+30 C) and 3 hours (+10 C) before applying the second coat of **Microresina Xtreme Invisible**.

Tip: dilute the first coat to 15%.

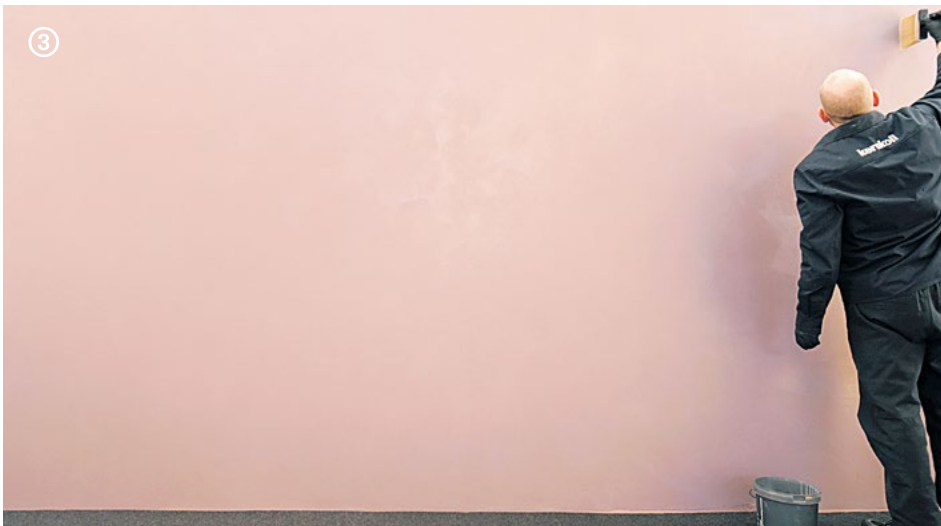

- If the 2nd coat is applied within 12 hours it is not necessary to sand the surface.
 - If a period of over 12 hours has passed, sand with Softpad.
 - After the application, use Tetra Fix Crystal sealant or Silicone Color to seal plaques, vents, shower cabinets in environments with frequent contact with water.
- Tip: wait 5 days before direct, continuous contact with water.

Wallpaper

Water-based resin covering with a coloured superflat smooth finish.

The matt and monochromatic surface of Wallpaper is ultra-smooth and silky to the touch. Its essential charm creates a minimalist atmosphere of great elegance and formal purity. Wallpaper is a specific cycle for bathroom and kitchen coverings.



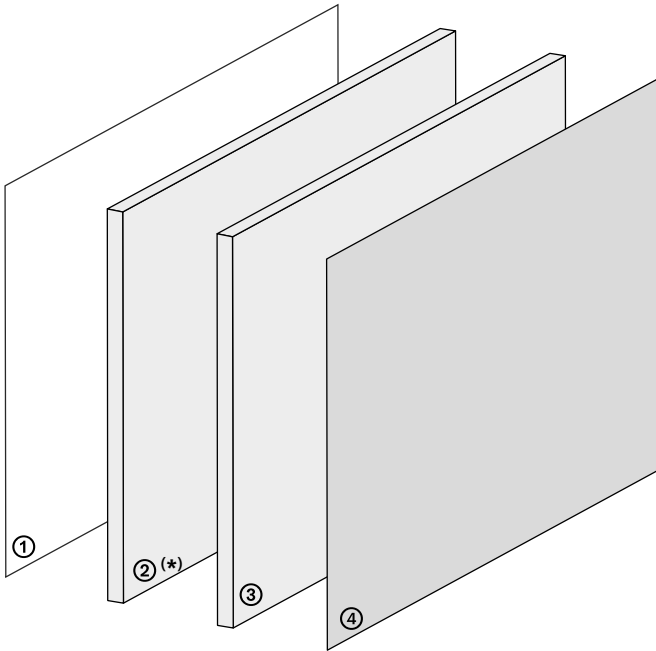

① Layer → Priming → according to substrate

Universal Wall Primer

Keragrip Eco Pulep

② Layer → Base finishing coat (*)

Wallcrete

(*) Mandatory finishing coat for shower interiors or irregular substrates such as plasters and ceramic tiles.

③ Layer → Skimming

Wallpaper

④ Layer → Coloured finish and protection

Microresina

① Layer → Priming

Preparation

Warnings about substrates

- The substrates must be permanently dry and free from rising damp.
- Maximum residual moisture on cement based and ceramic substrates: < 2%.
- Maximum residual moisture on gypsum and anhydrite based substrates: < 1%.
- Temperature range for application: from +10 °C to +30 °C.
- Relative environmental humidity: ≤ 75%.

Suitable substrates

- Cement based plasters and finishing products, lime and gypsum.
- Substrates made with plasterboard and fibre-cement panels.
- Ceramic, glass mosaic and natural stone previous coatings.
- Plywood and MDF panels.
- Waterproofing carried out with systems such as Aquastop Extreme, Aquastop Nanogum, Nanoflex No Limits, Nanodefence Eco or Aquastop Nanoflex (proceed straightaway with Wallcrete used as a finishing product).

Universal Wall Primer

Water based universal primer for walls.



Products

Pack - 1 l - 5 l - 10 l



Coverage

≈ 150 - 200 ml/m²



Tools

Brush and roller

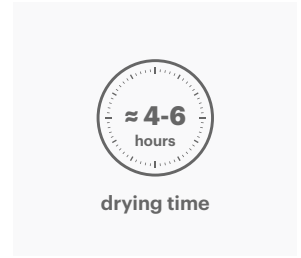

Time

Waiting time for overlaying:
≈ 4 - 6 hours

Keragrip Eco Pulep

Organic preparation coat for treatment and cleaning of non-absorbent substrates.



Products

Pack - 1 l - 10 l



Coverage

≈ 30 ml/m²

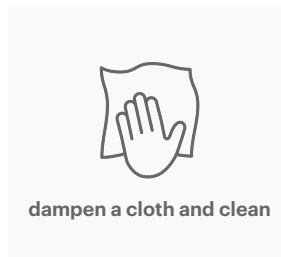

Tools

cloth

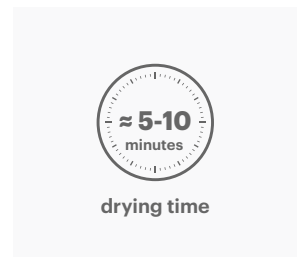

Time

Waiting time for overlaying:
≈ 5-10 minutes

② Layer → Base finishing coat (*)

Preparation

Ready-to-use

→ Remix the product inside the container to ensure the mixture is of an even consistency.

(*) Mandatory finishing coat for shower interiors or irregular substrates such as plasters and ceramic tiles.

Wallcrete

Texturizing base finishing coat for shower interiors or irregular substrates for Wallpaper covering.



Products

Pack – 5 kg - 15 kg



Coverage

≈ 2.0 kg/m² for two coats

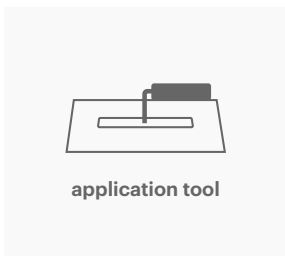

Tools

Trowel

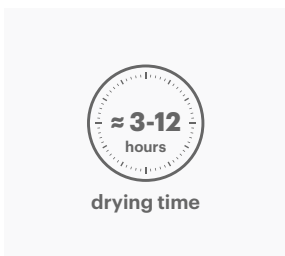

Time

Once the material has hardened: ≈ 3-12 hours

② Layer → Base finishing coat (*)

Wallcrete



→ Apply the 1st coat of **Wallcrete** spreading the joints off completely in order to grout them.

→ On plasters or finishing coats, carefully smooth evening the substrate.

Tip: on walls presenting traces, cracks or unstable crazing, insert Net 90 reinforcing mesh in the 1st coat of **Wallcrete**.

If any wall need to be corrected or levelled, order Wallzero.

→ To speed up drying times (especially in damp environments and/or with little air circulation), the use of a fan is recommended.



→ The 2nd coat has the purpose to completely cover the substrate defects and even the wall.

Tip: if obvious crests or flashes are present, sand in order to remove them before applying the second coat.

③ Layer → Skimming

Preparation

Ready-to-use

→ Remix before use; the paste must be smooth, consistent and without lumps.

Wallpaper

Superflat, high performance finish plaster for Wallpaper resin covering.



Products

Pack – 5 kg



Coverage

≈ 1,5 kg/m²

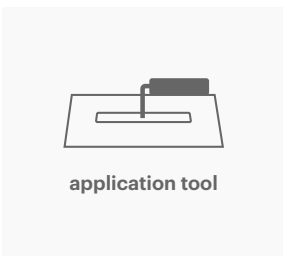

Tools

Trowel

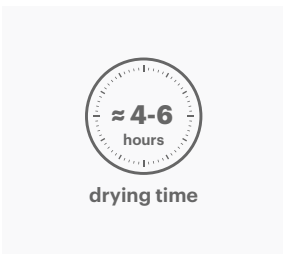

Time

Waiting time for the sanding and the top application: ≈ 4 - 6 hours

③ Layer → Skimming

Wallpaper



→ Apply the 1st coat of Wallpaper spreading the product on the surface in order to even and level it.

Tip: a drop of water may be added in order to make the product more workable.

If crests or flashes are present, sand in order to remove them before applying the subsequent coat. Apply repeated coats until a perfectly flat surface is obtained.



→ Apply the product on the previous dry coat, until a perfectly even surface is achieved.

→ Before applying Microresina, check that the surface is perfectly even; if necessary, apply a further coat.

Tip: we recommend to sand the final coat with a 240-grain sandpaper to achieve a perfectly even surface.

Wait at least 12 hours before re-applying Microresina.

④ Layer → Coloured finish and protection

Preparation

Warning

- Before use, stir part A, add the hardening compound whilst stirring in the ratio part A : part B = 5 : 1 and mix well until completely blended.
- Dilute using clean water up to 10% and mix again.
- At the end of the cycle, wait for 5 days before direct, continuous contact with water.

Microresina

Coloured water based micro-resin with varnished matt finish for the protection of Wallpaper technical covering.



Products

Pack – (1+0.2) 1.2 kg e (2.5+0.5) 3 kg



Coverage

≈ 300 g/m² for two-three coats

Dilution – max 10%

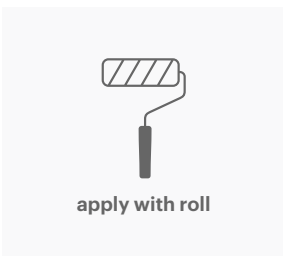

Tools

Roller

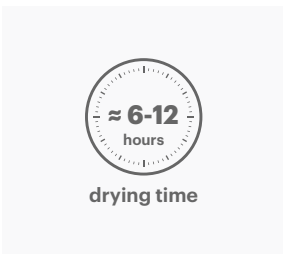

Time

Waiting time between 1st and 2nd coat: ≈ 6-12 hours (covering)

Waiting time between subsequent coats: ≈ 2-12 hours

④ Layer → Coloured finish and protection

Microresina



→ Before use, stir part A, add the hardening compound whilst stirring in the ratio part A : part B = 5 : 1. Mix well, then dilute 10% using clean water and mix again.



→ **Microresina** must be carefully applied with a roller over the whole surface in two-three coats, diluted to a maximum of 10%.
Tip: proceed with shaping by passing over the laid film while it is still wet.



- Help yourself with a spotlight to create a grazing light flush with the wall, and be able to check the perfect evenness of the wall.
- If there are small imperfections, grout promptly with Wallpaper before proceeding with the subsequent coats.



- Leave at least 6 hours between the 1st and 2nd coats.
- Waiting time between subsequent coats ≈ 2-12 hours.
- After the application, use Tetra Fix Crystal sealant or Silicone Color to seal plaques, vents, shower cabinets in environments with frequent contact with water.

Patina

Water-based resin covering with a delabr  plaster texture and natural shaded finish.

The surface of Patina is velvety to the touch and characterized by ripples and material vibrations resulting from the imperfections of hand-made processing.

The uneven colour and the unique effects in light reflection create a sophisticated sense of imperfection.

Patina is a specific cycle for bathroom and kitchen coverings.

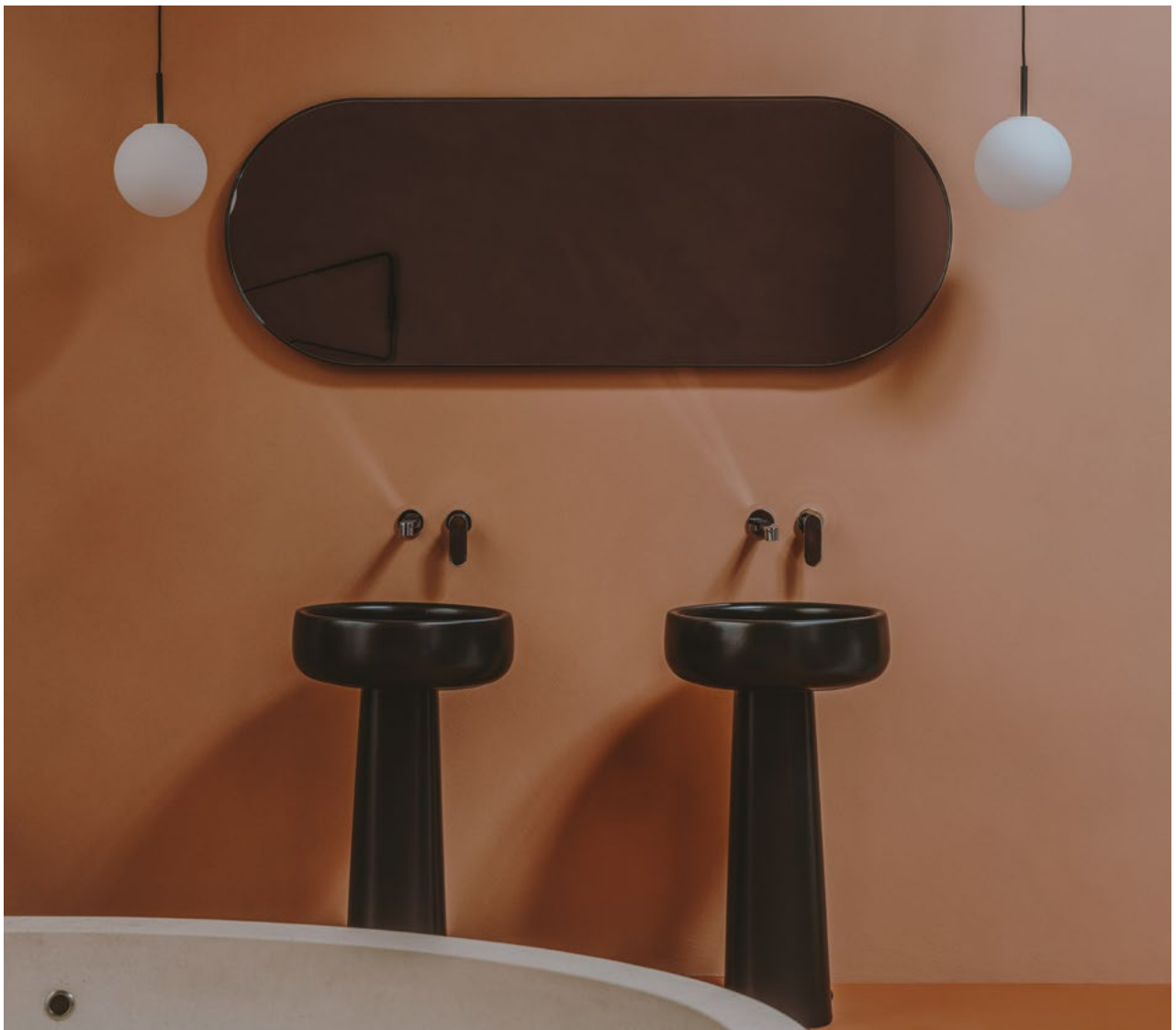

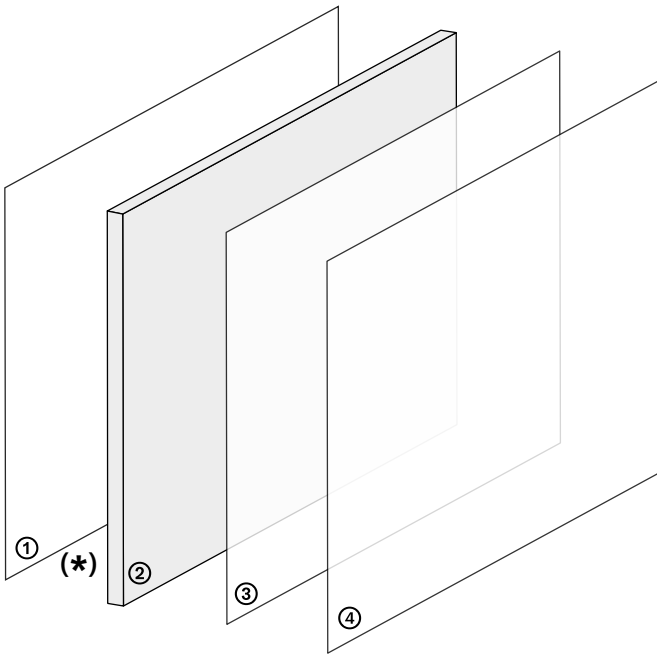

① Layer → Priming → according to substrate

Universal Wall Primer

(*) Keragrip Eco Pulep + Wallcrete

On substrates made of ceramic, prime with Keragrip Eco Pulep and proceed with a base finishing coat using **Wallcrete** (see page 23).

② Layer → Skimming

Patina

③ Layer → Impregnating protective product

Finish

④ Layer → Transparent protective

Microresina Xtreme Invisible

① Layer → Priming

Preparation

Warnings about substrates

- The substrates must be permanently dry and free from rising damp.
- Maximum residual moisture on cement based and ceramic substrates: < 2%.
- Maximum residual moisture on gypsum and anhydrite based substrates: < 1%.
- Temperature range for application: from +10 °C to +30 °C.
- Relative environmental humidity: ≤ 75%.

Suitable substrates

- Cement based plasters and finishing products, lime and gypsum.
- Substrates made with plasterboard and fibre-cement panels.
- Ceramic, glass mosaic and natural stone previous coatings.
- Plywood and MDF panels.
- Waterproofing carried out with systems such as Aquastop Extreme, Aquastop Nanogum, Nanoflex No Limits, Nanodefence Eco or Aquastop Nanoflex (proceed straightaway with Patina).

Universal Wall Primer

Water based universal primer for walls.



Products

Pack - 1 l - 5 l - 10 l



Coverage

≈ 150 - 200 ml/m²



Tools

Brush and roller



Time

Waiting time for overlaying:
≈ 4 - 6 hours

Keragrip Eco Pulep

Organic preparation coat for treatment and cleaning of non-absorbent substrates.



Products

Pack - 1 l - 10 l



Coverage

≈ 30 ml/m²



Tools

cloth

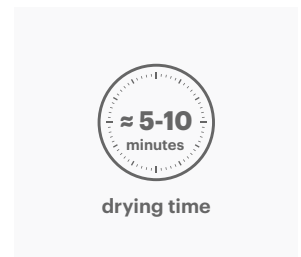

Time

Waiting time for overlaying:
≈ 5-10 minutes

② Layer → Skimming

Preparation

Ready-to-use

→ Remix the product inside the container to ensure the mixture is of an even consistency.

Patina

Water-based resin covering with a delabr  plaster texture and natural shaded finish.



Products

Pack – 15 kg



Coverage

≈ 3 kg/m² for three coats

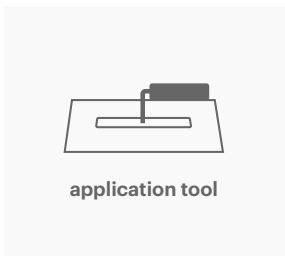

Tools

Trowel

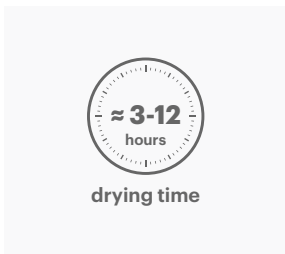

Time

Once the material has hardened: ≈ 3-12 hours

② Layer → Skimming

Patina



→ Apply the 1st coat of Patina spreading the product with small and even strokes of the spreader over the entire surface.

Tip: when applying, keep the spreader flat so as not to leave raised crests or notches.



→ To speed up drying times (especially in damp environments and/or with little air circulation), the use of a fan is recommended.



→ **Apply the 2nd coat once the material has hardened (3-12 hours).**

Tip: if crests or flashes are present, sand in order to remove them before applying the 3rd coat. A drop of water may be added in order to make the product more workable.

When applying the 3rd coat, add the exact same quantity of water in all mixes in order to avoid differences in colour.

→ **The 3rd coat has the purpose to define the final texture of the surface.**

Tip: when applying the 3rd coat of Patina, keep the spreader “flat”, that is almost parallel to the wall.

In order to obtain a more compact and natural shaded surface, spread and compact the product with the blade of the spreader during the drying phase (“touch dry”).

③ Layer → Impregnating protective product

Preparation

Ready-to-use

→ Remix the product inside the container to ensure the mixture is of an even consistency.

Finish

Protective water based impregnating product for Patina Living resin covering.



Products

Pack – 1.5 l



Coverage

≈ 80 ml/m² for one coat

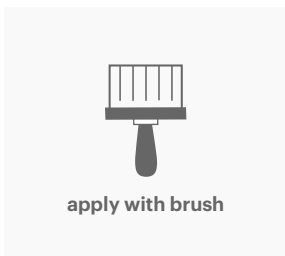

Tools

Brush

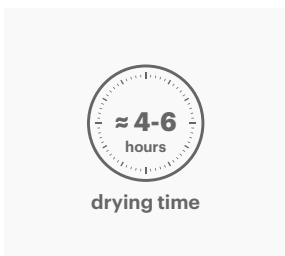

Time

Waiting time between 1st and 2nd coat: ≈ 4 - 6 ore

③ Layer → Impregnating protective product

Patina



→ Once the coloured texturizing finishing coat Patina has completely dried, apply the 1st coat of Finish by brush without sanding.

Tip: proceed with crossed strokes from the top downwards.



- After 4-6 hours, sand the surface with 80-120-grain sandpaper in order to remove any small imperfections and to make the surface smooth and pleasing to the touch.
- Remove any dust with a dry flat brush or a cotton cloth and then be ready to apply **Microresina Xtreme Invisible**.

④ Layer → Transparent protective

Preparation

Warning

- Shake part A before use and pour into a clean container.
- Add the hardening compound whilst stirring in the ratio part A : part B = 10 : 1.
- Mix well, then dilute 10% using clean water and mix again.
- At the end of the cycle, wait for 5 days before direct, continuous contact with water.

Microresina Xtreme Invisible

Transparent water based micro-resin for the protection of Patina technical covering.



Products

Pack - (1+0,1) 1.1 l e (2,5+0.25) 2,75 l



Coverage

≈ 180 ml/m² for three coats

Dilution - max 10 - 15%

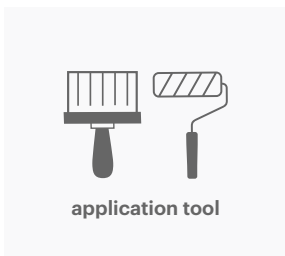

Tools

Brush and roller

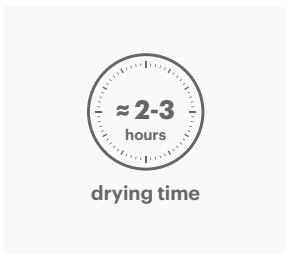

Time

Waiting time between 1st and 2nd coat: ≥ 2 - 3 hours

If > 12 hours elapse, sand with Softpad

④ Layer → Transparent protective

Microresina Xtreme Invisible



→ Before use, stir part A, add the hardening compound whilst stirring in the ratio part A : part B = 10 : 1.

→ Mix well, then dilute 10% using clean water and mix again.



→ Apply 2 or 3 coats of **Microresina Xtreme Invisible** with **Roller Plus** or a flat brush respecting the coverage of $\approx 60 \text{ ml/m}^2$ per coat.

→ Waiting time for the overlaying of the 2nd and 3rd coats of **Microresina Xtreme Invisible**: $\approx 2\text{-}3$ hours.

Tip: dilute the 1st coat to 15%.



- If the 2nd or 3rd coats are applied within 12 hours it is not necessary to sand the surface.
 - If a period of over 12 hours has passed, sand with **Softpad**.
 - After the application, use **Tetra Fix Crystal** sealant or **Silicone Color** to seal plaques, vents, shower cabinets in environments with frequent contact with water.
- Tip: wait 5 days before direct, continuous contact with water.

Surfaces and Uses

Surfaces

paints

Absolute
Decor

Resin-based Coating materials

Decorative coverings
Wallcrete Living
Wallpaper Living
Patina Living
Stripe Living

Technical coverings*

Wallcrete
Wallpaper
Patina

Microresina

Microresina
Microresina Floor
Microresina Parquet

Cementoresina

Cementoresina
Cementoresina Wall

Legno+Color

Legno+Color S, M, L

Finishes for external application

Outdoor Paint
Outdoor Plaster

Skirting board

Invisibile

Use

Walls and ceilings

Absolute
Decor

Decorative walls

Wallcrete Living
Wallpaper Living
Patina Living
Stripe Living

Technical walls*

Wallcrete
Wallpaper
Patina
Cementoresina Wall

Floors

Cementoresina
Legno+Color S, M, L
Microresina Floor
Microresina Parquet

Re-color**

Microresina

External facades

Outdoor Paint
Outdoor Plaster

* Walls of bathrooms and kitchens.

** Doors, internal and external fixtures, joinery and ceramic coverings.

Kerakoll Spa
via dell'Artigianato 9
41049 Sassuolo (MO) Italy
T +39 0536 816 511
info@kerakoll.com

Kerakoll Brera Studio
via Solferino 16
20121 Milano (MI) Italy
T +39 02 620 867 81

N.B.

This Site manual has been drafted on the basis of the best technical and practical knowledge of Kerakoll S.p.A.

It is, however, a set of guides and information of a general nature that do not consider the real situations of individual structures; therefore, the coverage information is to be considered merely indicative.

Kerakoll does not intervene directly in the building site conditions, the specific design of the project, and the execution of the work; the information and guidelines mentioned here do not commit Kerakoll in any way.

The designer in charge is responsible for the entire structural design in accordance with Italian Ministerial Decree 17/01/2018 and its amendments or additions.

All rights reserved. © Kerakoll. All rights to the content of this publication are reserved in accordance with applicable law.

The duplication, publication, and distribution, in full or in part, of all material contained herein, are expressly forbidden without written authorization. Additions and/or amendments to this information may be made over time by KERAKOLL Spa; for the latest version, see www.kerakoll.com.

KERAKOLL Spa shall therefore be liable for the validity, accuracy and updating of information provided only when taken directly from its institutional website. For information on the product safety data, refer to the corresponding sheets provided in accordance with the law along with the health labelling on the packaging. Finally, it is advisable to perform a preliminary test of each product to verify its suitability for your purposes.

kerakoll



kerakoll.com